

Product data sheet

Specifications



TeSys F contactor - 3P (3 NO) - AC-3 - ≤ 440 V 400 A - coil 110 V AC

LC1F400F7

⚠ Discontinued on: Dec 30, 2024

⚠ Discontinued

Product availability: Stock - Normally stocked in distribution facility

Main

Range	TeSys
Range of Product	TeSys F
Product or Component Type	Contactor
Device short name	LC1F
Contactor application	Resistive load Motor control
Utilisation category	AC-1 AC-4 AC-3
Poles description	3P
[Ue] rated operational voltage	≤ 1000 V AC 50/60 Hz ≤ 460 V DC
[Uc] control circuit voltage	110 V AC 40...400 Hz
[Ie] rated operational current	500 A (at <104 °F (40 °C)) at ≤ 440 V AC AC-1 400 A (at <131 °F (55 °C)) at ≤ 440 V AC AC-3

Complementary

[Uimp] rated impulse withstand voltage	8 kV
[Ith] conventional free air thermal current	500 A (at 104 °F (40 °C))
Rated breaking capacity	3200 A conforming to IEC 60947-4-1
[Icw] rated short-time withstand current	3600 A 104 °F (40 °C) - 10 s 2400 A 104 °F (40 °C) - 30 s 1700 A 104 °F (40 °C) - 1 min 1200 A 104 °F (40 °C) - 3 min 1000 A 104 °F (40 °C) - 10 min
Associated fuse rating	400 A aM at ≤ 440 V 500 A gG at ≤ 440 V
Average impedance	0.26 mOhm - Ith 500 A 50 Hz
[Ui] rated insulation voltage	1000 V IEC 60947-4-1 1500 V VDE 0110 group C
Power dissipation per pole	65 W AC-1 42 W AC-3
Overtoltage category	III
power pole contact composition	3 NO

Price is "List Price" and may be subject to a trade discount – check with your local distributor or retailer for actual price.

Motor power kW	75 kW at 400 V AC 50/60 Hz (AC-4) 200 kW at 380...400 V AC 50/60 Hz (AC-3) 220 kW at 415 V AC 50/60 Hz (AC-3) 250 kW at 440 V AC 50/60 Hz (AC-3) 257 kW at 500 V AC 50/60 Hz (AC-3) 280 kW at 660...690 V AC 50/60 Hz (AC-3) 185 kW at 1000 V AC 50/60 Hz (AC-3) 110 kW at 220...230 V AC 50/60 Hz (AC-3)
Control circuit voltage limits	Operational 0.85...1.1 Uc 40...400 Hz 131 °F (55 °C)) Drop-out 0.3...0.5 Uc 40...400 Hz 131 °F (55 °C))
Mechanical durability	10 Mcycles
Inrush power in VA	1075 VA, 40...400 Hz 0.9 68 °F (20 °C))
Hold-in power consumption in VA	15 VA, 40...400 Hz 0.9 68 °F (20 °C))
Maximum operating rate	2400 cyc/h 131 °F (55 °C)
Operating time	40...65 ms closing 100...170 ms opening
Connections - terminals	Control circuit screw clamp terminals 1 0.002...0.006 in ² (1...4 mm ²)flexible without cable end Control circuit screw clamp terminals 2 0.002...0.006 in ² (1...4 mm ²)flexible without cable end Control circuit screw clamp terminals 1 0.002...0.006 in ² (1...4 mm ²)flexible with cable end Control circuit screw clamp terminals 2 0.002...0.004 in ² (1...2.5 mm ²)flexible with cable end Control circuit screw clamp terminals 1 0.002...0.006 in ² (1...4 mm ²)solid without cable end Control circuit screw clamp terminals 2 0.002...0.006 in ² (1...4 mm ²)solid without cable end Power circuit bar 2 30 x 5 mm Power circuit lugs-ring terminals 2 0.2 in ² (150 mm ²) Power circuit bolted connection
Tightening torque	Control circuit 10.6 lbf.in (1.2 N.m) Power circuit 309.8 lbf.in (35 N.m)
Mounting Support	Plate
Heat dissipation	14 W
motor power range	110...220 kW 480...500 V 3 phase 110...220 kW 380...440 V 3 phase 110...220 kW 200...240 V 3 phase 250...500 kW 480...500 V 3 phase
Motor starter type	Direct on-line contactor
Contactor coil voltage	110 V AC standard
Standards	IEC 60947-1 JIS C8201-4-1 IEC 60947-4-1 EN 60947-4-1 EN 60947-1
Product Certifications	BV UL CB ABS RINA CSA RMRoS DNV LROS (Lloyds register of shipping) UKCA
Compatibility code	LC1F
Control circuit type	AC 40...400 Hz

Environment

IP degree of protection	IP20 front face with shrouds IEC 60529 IP20 front face with shrouds VDE 0106
Protective treatment	TH
Ambient air temperature for operation	23...131 °F (-5...55 °C)
Ambient Air Temperature for Storage	-76...176 °F (-60...80 °C)
Permissible ambient air temperature around the device	-40...158 °F (-40...70 °C)
Height	8.1 in (206 mm)
Width	8.4 in (213 mm)
Depth	8.6 in (219 mm)
Operating altitude	9842.52 ft (3000 m) without derating
Net Weight	20.06 lb(US) (9.1 kg)

Ordering and shipping details

Category	US10I1222336
Discount Schedule	0112
GTIN	3389110226942
Returnability	Yes
Country of origin	CZ

Packing Units

Unit Type of Package 1	PCE
Nbr. of units in pkg.	1
Package 1 Height	9.8 in (25.0 cm)
Package 1 Width	11.4 in (29.0 cm)
Package 1 Length	9.4 in (24.0 cm)
Package weight(Lbs)	20.41 lb(US) (9.26 kg)
Unit Type of Package 2	P06
Number of Units in Package 2	10
Package 2 Height	30.3 in (77.0 cm)
Package 2 Width	31.5 in (80.0 cm)
Package 2 Length	23.6 in (60.0 cm)
Package 2 Weight	224.98 lb(US) (102.05 kg)

Contractual warranty

Warranty	18 months
-----------------	-----------



Environmental Data

Schneider Electric aims to achieve Net Zero status by 2050 through supply chain partnerships, lower impact materials, and circularity via our ongoing “Use Better, Use Longer, Use Again” campaign to extend product lifetimes and recyclability.

[Environmental Data explained >](#)



[How we assess product sustainability >](#)

 Environmental footprint	
Carbon footprint (kg CO2 eq, Total Life cycle)	3555
Environmental Disclosure	Product Environmental Profile

Use Better

 Materials and Substances	
Packaging made with recycled cardboard	Yes
Packaging without single use plastic	No
EU RoHS Directive	Compliant with Exemptions
REACH Regulation	REACH Declaration
California proposition 65	WARNING: This product can expose you to chemicals including: Lead and lead compounds, which is known to the State of California to cause cancer and birth defects or other reproductive harm. For more information go to www.P65Warnings.ca.gov

Use Again

 Repack and remanufacture	
Recyclability potential, in %	95
Circularity Profile	End of Life Information
Take-back	No
WEEE Label	 The product must be disposed on European Union markets following specific waste collection and never end up in rubbish bins.

Dimensions Drawings

Dimensions and Drawings

LC1 F400 and F500

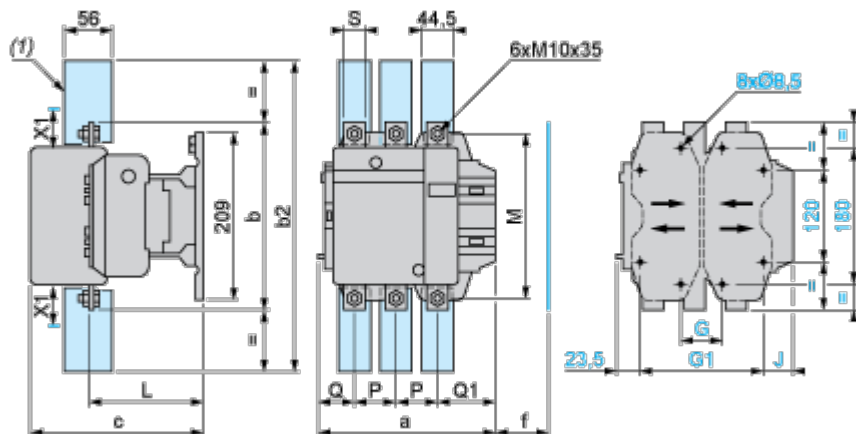

(1) Power terminal protection shroud

NOTE: X1 (mm) = Minimum electrical clearance according to operating voltage and breaking capacity.

LC1	200...500 V	600...1000 V
F400	15	20
F500	15	20

LC1		a	b	b2	c	f	G supplied	G min.	G max.	G1 supplied	G1 min.	G1 max.	J	L	M	P	Q	Q1
F400	2P	213	206	375	219	146	80	66	102	170	156	192	19.5	145	181	48	69	96
	3P	213	206	375	219	146	80	66	102	170	156	192	19.5	145	181	48	43	74
	4P	261	206	375	219	146	80	66	150	170	156	240	67.5	145	181	48	43	74
F500	2P	233	238	400	232	150	80	66	120	170	156	210	39.5	146	208	55	76	102
	3P	233	238	400	232	150	80	66	120	170	156	210	39.5	146	208	55	46	77
	4P	288	238	400	232	150	140	66	175	230	156	265	34.5	146	208	55	46	77

TeSys F reversing contactors and changeover contactor pairs Vertically mounted

NOTE: For customer assembly, with mechanical interlock (MI) LA9 F, fixing recommended on AM1 EC uprights (please consult your Regional Sales Office). 2 x LC1 identical or different ratings (LC1 F115 to F630 and F800).

Assembly A

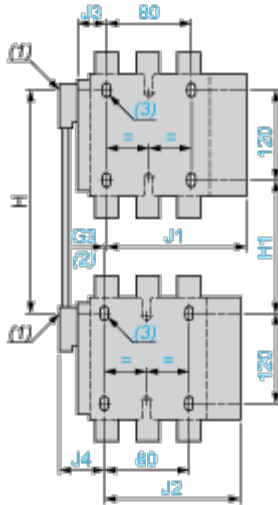

- (1) Mechanical interlock shaft.
- (2) For assembly of contactors of different ratings only.
- (3) 4 x Ø6.5 for LC1 F115 to F225.

Assembly A⁽⁷⁾ - Mechanical interlock reference

	G3 3P	G3 4P	H min.	H max.	H1 min.	H1 max.	J1 3P	J1 4P
LA9 FF4F	0	0	200	310	80	190	137	155.5
LA9 FG4F	3	4	210	300	90	180	139.5	159.5
LA9 FG4G	0	0	220	310	100	190	139.5	159.5

	J2 3P	J2 4P	J3 3P	J3 4P	J4 3P	J4 4P
LA9 FF4F	137	155.5	48.5	67	48.5	67
LA9 FG4F	137	155.5	53	73	54	69
LA9 FG4G	139.5	159.5	53	73	53	73

Assembly B

	H1 min.	H1 max.	J1 3P	J1 4P	J2 3P	J2 4P	J4 3P	J4 4P
LA9 FL4G	150	220	248.5	328.5	139.5	159.5	53	73

Assembly C

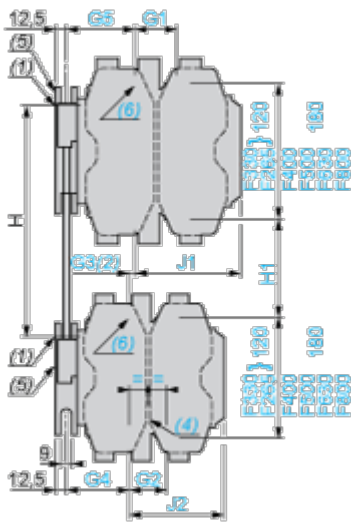

(6) 4 x Ø8.5 for LC1 F400, F500 or 4 x Ø10.5 for LC1 F630 and F800.

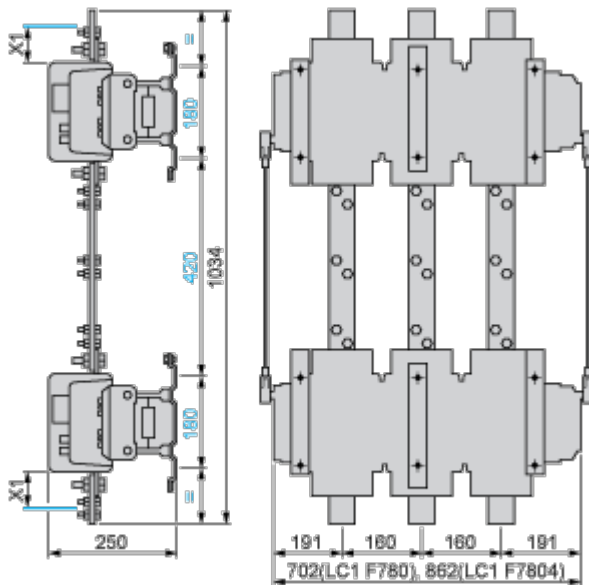

(7) Only 3P for F800.

(8) In this case, G4 is greater than G5.

Assembly C⁽⁷⁾

	G1 3P	G1 4P	G2 3P	G2 4P	G3 3P	G3 4P	G4 3P	G4 4P	G5 3P	G5 4P
LA9 FH4H	96	96	96	96	0	0	60	83	60	83
LA9 FJ4H	80	80	96	96	23	0	60	83	83	83
LA9 FK4H	80	140	96	96	23	0	60	83	83	83

	G1 3P	G1 4P	G2 3P	G2 4P	G3 3P	G3 4P	G4 3P	G4 4P	G5 3P	G5 4P
LA9 FL4H	180	240	96	96	14	g ⁽⁸⁾	60	83	74	74
LA9 FJ4J	80	80	80	80	0	0	83	83	83	83
LA9 FK4J	80	140	80	80	0	0	83	83	83	83
LA9 FL4J	180	240	80	80	g ⁽⁸⁾	g ⁽⁸⁾	83	83	74	74
LA9 FK4K	80	140	80	140	0	0	83	83	83	83
LA9 FL4K	180	240	80	140	g ⁽⁸⁾	g ⁽⁸⁾	83	83	74	74
LA9 FL4L	180	240	180	240	0	0	74	74	74	74

	H min.	H max.	H1 min.	H1 max.	J1 3P	J1 4P	J2 3P	J2 4P
LA9 FH4H	250	380	130	260	157.5	181.5	157.5	181.5
LA9 FJ4H	260	380	110	230	144.5	192.5	157.5	181.5
LA9 FK4H	280	380	130	230	164.5	219.5	157.5	181.5
LA9 FL4H	330	380	170	220	248.5	328.5	157.5	181.5
LA9 FJ4J	260	380	60	200	144.5	192.5	144.5	192.5
LA9 FK4J	280	380	100	200	164.5	219.5	144.5	192.5
LA9 FL4J	325	380	140	195	248.5	329.5	144.5	192.5
LA9 FK4K	300	380	120	200	164.5	329.5	164.5	219.5
LA9 FL4K	345	380	160	195	248.5	328.5	164.5	219.5
LA9 FL4L	380	380	200	200	248.5	328.5	248.5	328.5

Connections and Schema

Connections and Schema

2, 3, and 4-pole Contactors

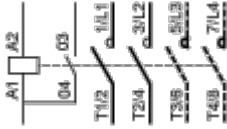

LC1 F115 to F630, F1250 (coil LX1 F )

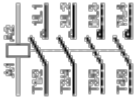

LC1 F115 to F630, F1250 (coil LX4 F )

LC1 F115 to F265 (coil LX9 F )

LC1 F800 (coil LX8 F )